



...intelligent solutions

with **UNI-JET** – the new **tilt-turn**
fitting system from Gretsch-Unitas

the system with the
Cleverle

More...

...flexibility
with UNI-JET

These are the top features you will profit from in the future:

More flexibility

- ▶ Applicable for all sizes of window fabricators.
- ▶ Manual and automatic assembly possible.

More security

- ▶ Choice of locking plates for a choice of security levels.
- ▶ All locking points are provided with steel mushroom pins.

More convenience

- ▶ The mushroom pin **Cleverle** automatically adjusts itself to the rebate clearance.
- ▶ All adjustments with Torx.

More efficiency

- ▶ Fewer hardware components.
- ▶ Reduced storage cost.
- ▶ Time saving assembly.

More quality

- ▶ Optimum corrosion protection due to ferGUard* silver coating.
- ▶ Stylish hinge design.
- ▶ Competent technical advice.

You look for less complication in your work? Clear case – more simplicity is impossible. One system for all applications!

UNI-JET is suitable for manual and automatic hardware assembly with all window materials.

This means, UNI-JET is

applicable for all window fabricators of any size.

Your stock will be straightforward and manageable without you missing anything. Quite the contrary, the versatile application possibilities of the hardware system save you storage room, reduce your storage cost and simplify your organisation.



UNI-JET
The new
tilt-turn hardware system
is ideally suited for
all current window materials.

More...

...security
with **UNI-JET**

Using new market opportunities and heading for success with one new tilt-turn fitting system!

More security than ever before! The magic word is "retrofitting": Depending on the type of locking plate, the security level can be varied, i.e. enhanced at any time by choosing another type.

Further advantages:

- 1** Simplified application: The central lock is suitable for all resistance classes from standard to resistance class WK 2.
- 2** Resistance class WK 3 is achieved with a few additional components.
- 3** All locking points are provided with steel mushroom pins – another security plus.
- 4** An additional warranty for security is the load capacity of the stay arm bearing for sash weights up to 130 kg.

UNI-JET: Security that convinces!





All current security levels can be realized: various locking plates for various demands on security.



UNI-JET – the new tilt-turn hardware system guarantees utmost security and versatile application.

UNI-JET

The resistance class is determined by the type of locking plate.

More...

...convenience
with **UNI-JET**

What does more convenience mean to you?

Welcome to the **Cle~~v~~erle!** Automatically on the right place: The **Cle~~v~~erle** is an automatic pin on all locking points. Cleverly it compensates for rebate clearance deficiencies which sometimes occur. All adjustments are carried out with Torx. This means, assembly is easier, more convenient and more efficient.

Further advantages:

- 1 Eye-catching appearance of the window!
The hinges come in a new design.
- 2 Comfort is asked for! Therefore, the tilt-turn stays are provided with integrated slit ventilation as a standard.
- 3 Sash positioner for permanent ease of opening and closing.
- 4 Each automatic pin is adjustable for pressure.
- 5 Anti-bang security device in the stay arm.
- 6 The gear is prepared for a clip-on fabricator's logo.
- 7 All components move smoothly.
- 8 Optional: adjustable sash break in the corner hinge.

UNI-JET will bring you even more customer satisfaction!

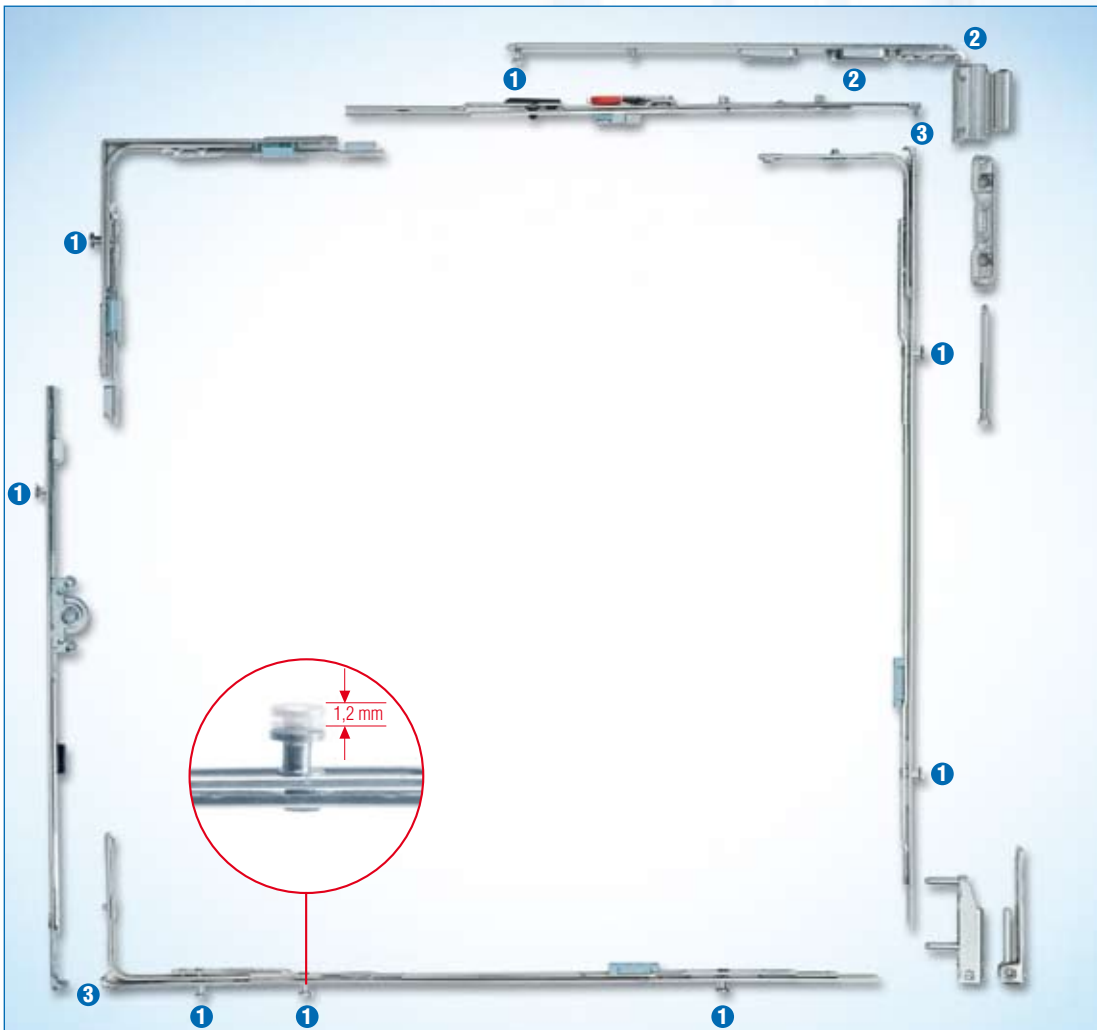

Practical and safe

- ❶ All locking points with automatic pin which cleverly adjusts to rebate clearance.
- ❷ Stay arms with multi-stage slit ventilation.
- ❸ Clip connection of locking gear and stay arm connecting plate.



❶ **Make it all round**
Automatic pin

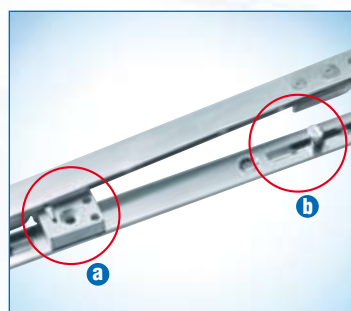

❷ **Make it suit**
Stay arm with slit ventilation
a optional b standard



❸ **Make it snappy**
Clip connection of stay arm connecting plate and locking gear.

Cleverle

More...

...efficiency
with **UNI-JET**

How important is time to you? If you want to save time, we have the right solutions.

Let us show you how: All fitting components on the sash clip together. Now with G.U: Both gears and horizontal middle locks are clipped together and stay arm connecting plates and vertical middle locks. Hardware assembly has become even more efficient, no matter whether manual or automatic. If something works easily and covers many functions at once, this means real saving of time for you. With the new UNI-JET, the number of parts required to meet the demands of the market (security classes Standard, AhS, WK 2 etc.) is considerably reduced. Due to this reduction savings are achieved in merchandise planning, operations scheduling, storage and assembly. You will have more time for your new customers!

Further advantages

- 1** ▶ Less is more! For the bottom tilt locking, only one locking plate is required for both the tilting and the locking function. A separate tilt locking plate is no longer necessary.
- 2** ▶ UNI-JET and older versions of JET are compatible. UNI-JET fittings smoothly flow in the fabrication.

With UNI-JET you will have more time for your customers!



Tilt-turn sash
1 sash –
resistance
class WK 2

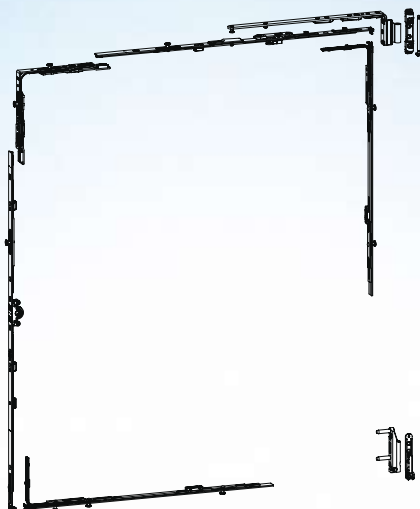

Less is more! Only one locking plate for both tilting and locking.

Tilt-turn sash
2 sashes –
resistance
class WK 2

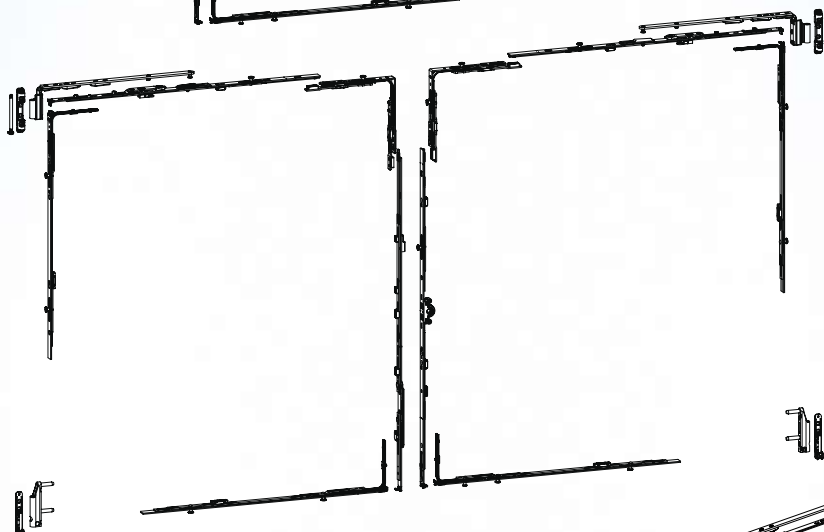

Round
arch head
window

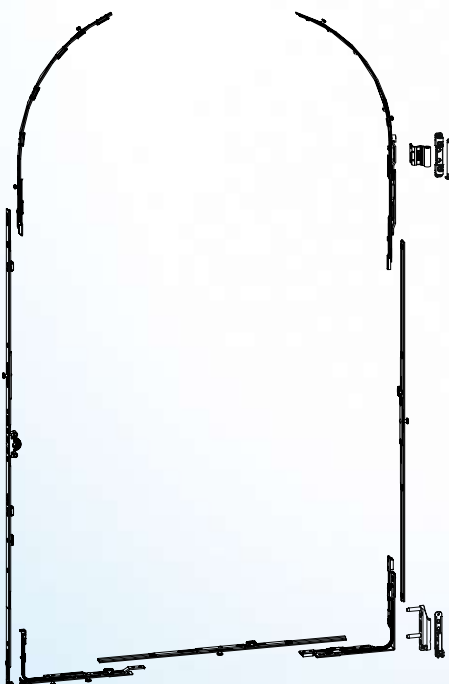

Oblique angle
head window

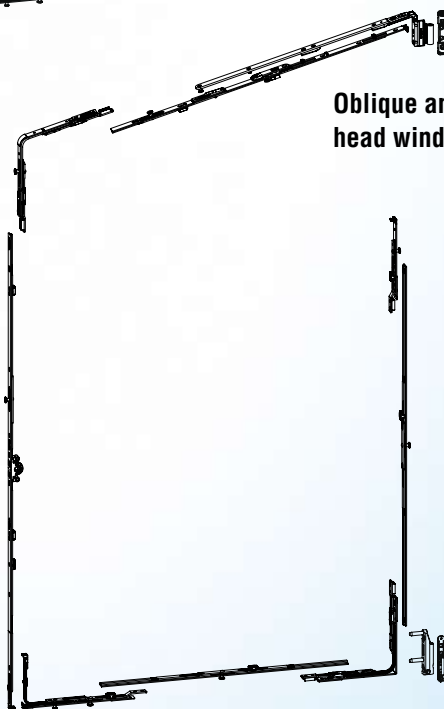

More...

...quality
with **UNI-JET**

All depends on the right material mixture! A well compounded finish lasts longer. Quality means more satisfaction.

The finish that really got it! FerGUard*silver optimally and reliably protects all fitting parts against corrosion.

Outstanding weather resistance is achieved with a special surface coating which is extremely solid and long-lasting. Further quality improvement is obtained by the use of steel mushroom pins. Your customers certainly attach great importance to longevity.

Further advantages:

- 1 ▶ UNI-JET with guaranteed quality.
- 2 ▶ Sophisticated hinge design.
- 3 ▶ Long parts in assembly-friendly flat packages.
- 4 ▶ Reliable delivery due to modern logistics.
- 5 ▶ Competent technical advice from our in house and field service.

Beautiful design and valuable functions – your customers will get enthusiastic!



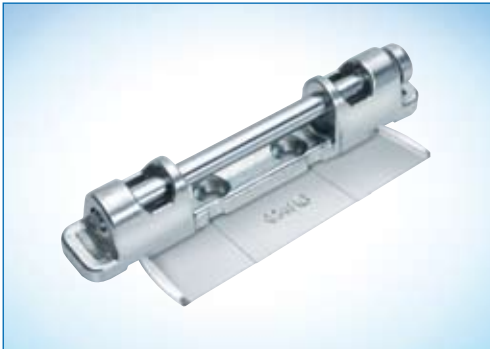

Mill-in stay arm bearing

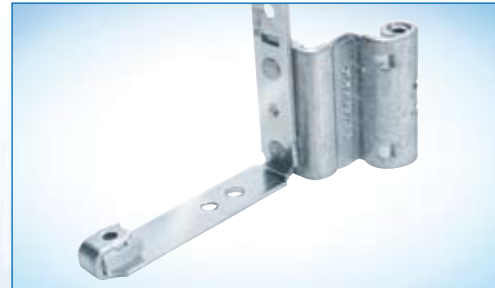

Rebate corner hinge



Screw-on stay arm bearing



Drill-in hinge



Stay arm bearing, e.g. for PVC profiles



Improved design – sash break integrated in stay arm hinge



Stay arm bearing UNI-JET DV



Sash bearing UNI-JET DV



Stay arm bearing UNI-JET S Contura



Corner hinge bottom UNI-JET S Contura



Flat package assembly-friendly package of all long parts



**Group of companies Gretschnitas:
We are strong wherever security is concerned!**

- ▶ Window technology
- ▶ Door technology
- ▶ Automatic entrance systems
- ▶ Window and door management
- ▶ Project advice

Quick and easy assembly.

Smaller amounts of fitting parts reduce assembly times and costs.

Our field staff will be pleased to introduce to you the new G.U tilt-turn system UNI-JET and to make you familiar with the advantages of the product. Ask for more information.

Gretschnitas GmbH Baubeschlage

Johann-Maus-Str. 3
D-71254 Ditzingen
Phone: +49 71 56 - 301-0
Fax: +49 71 56 - 301-293
www.g-u.de · vertrieb-ausland@g-u.de

BKS GmbH

Heidestr. 71
D-42549 Velbert
Phone: +49 2051 - 201-0
Fax: +49 2051 - 201-431
www.bks.de